

# VMU-C EM system



## Integrated modular system to monitor conventional energy



### Description

VMU-C EM is a modular system that records, monitors and transmits analog and digital signals from an industrial, commercial or residential installation with a specific focus on energy efficiency.

The system includes a web server with a powerful and intuitive user interface to monitor data and set up the system.

Data can be transmitted using various protocols (FTP, HTTP, Modbus TCP/IP) and via wired or wireless connection.

### Benefits

- **Integrated system.** The system is a package of integrated modules. The main module includes the web server with a web interface to monitor and set up the system.
- **Integrated Software.** No subscriptions or additional services are required.
- **Fast, easy and free updates.** Integrated software updates can be easily downloaded and installed via web interface, without losing data and without additional fees.
- **Communication flexibility.** The system transmits data (to CARLO GAVAZZI's or third party systems) via various communication protocols (FTP, HTTP, Modbus TCP/IP).
- **Scalability.** The system can be progressively integrated with new modules according to application needs.
- **Fast installation and set-up.** The entire system is installed and set up via web interface.
- **Reliability.** The system is secure against cyber attacks and computer viruses. Data redundancy and backup tools prevent information losses.
- **High monitoring capacity.** The system manages up to 32 3-phase meters, analog and digital inputs.
- **High recording capacity.** The system records data and events for a system for up to 30 years.
- **Compact size.** The maximum module package dimension is 8-DIN. Note: max number of energy meters depends on the meter type; check the table "VMU accessory modules and meters".

### Applications





It is ideal for scenarios where ease of use, scalability, data resilience and long-term reliability are essential. Given the type of industrial hardware, compact size and low energy consumption, it can be installed in both industrial and residential environments.

### Main functions

- Monitor energy control systems so as to check energy efficiency status and improvements.
- Record and display information.
- Transmit collected data.
- Manage alarms.

## VMU-C EM system modules

VMU-C EM system modules are:

Symbol	Name	Description
	VMU-C EM	Main module made up of a micro PC pre-installed with a web server. Communicates via various communication protocols. Monitors and records information and alarms. Transmits data supplied from energy meters and VMU-O EM and VMU-P EM accessory modules. One VMU-C EM module per system.
	VMU-M EM	Accessory module that controls VMU-O EM and VMU-P EM modules. Records and manages data provided by the modules. Maximum 10 VMU-M EM modules per system.
	VMU-O EM	Accessory module for digital inputs and outputs. Maximum 33 VMU-O EM modules per system.
	VMU-P EM	Accessory module for analog inputs. Maximum 11 VMU-P EM modules per system.
	VMU-D	Accessory module for mobile wireless transmission. One VMU-D module per system.

VMU-C EM system architecture (configuration maximums)

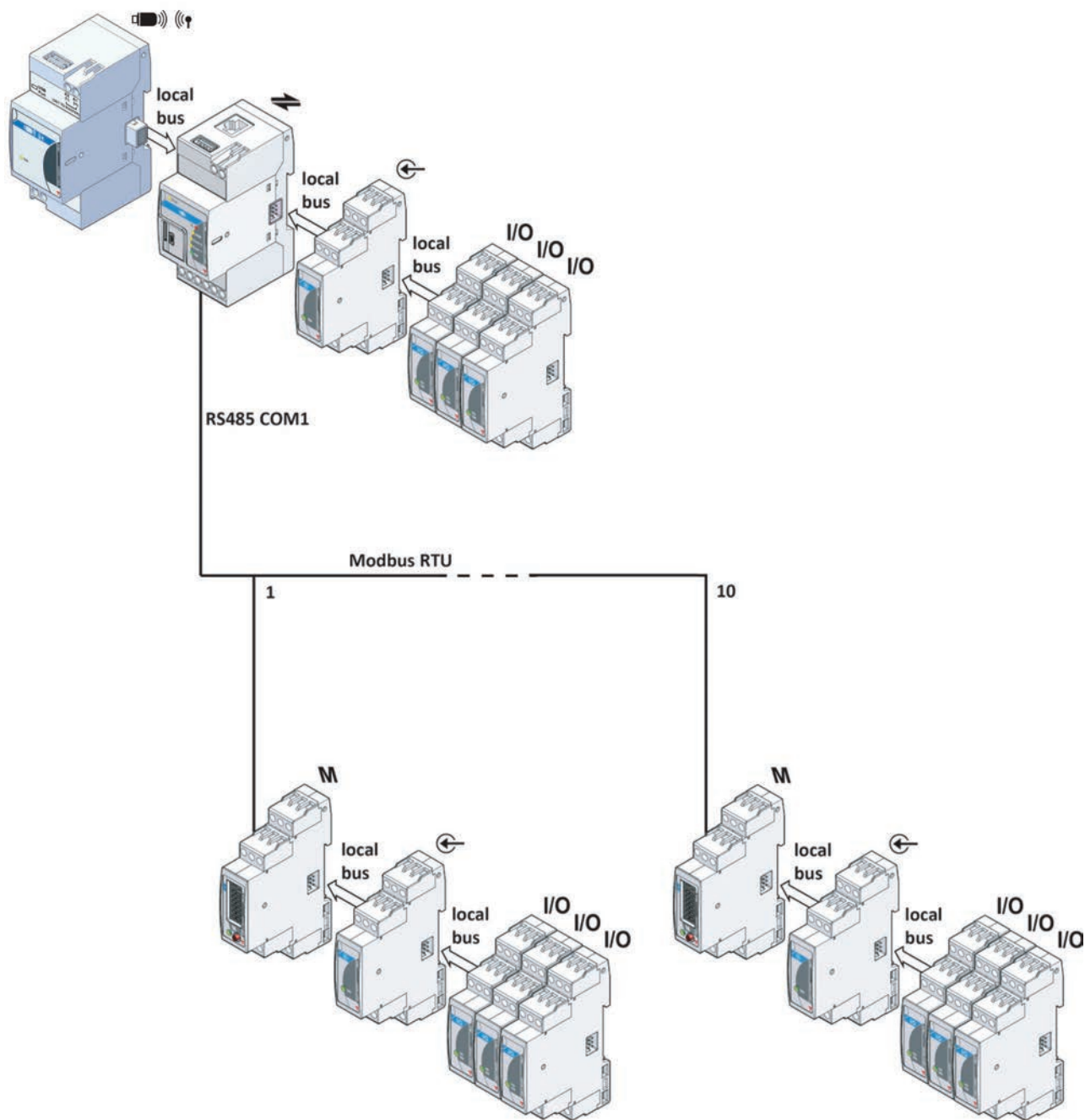

▶ VMU-C EM system communication architecture (inputs and outputs)

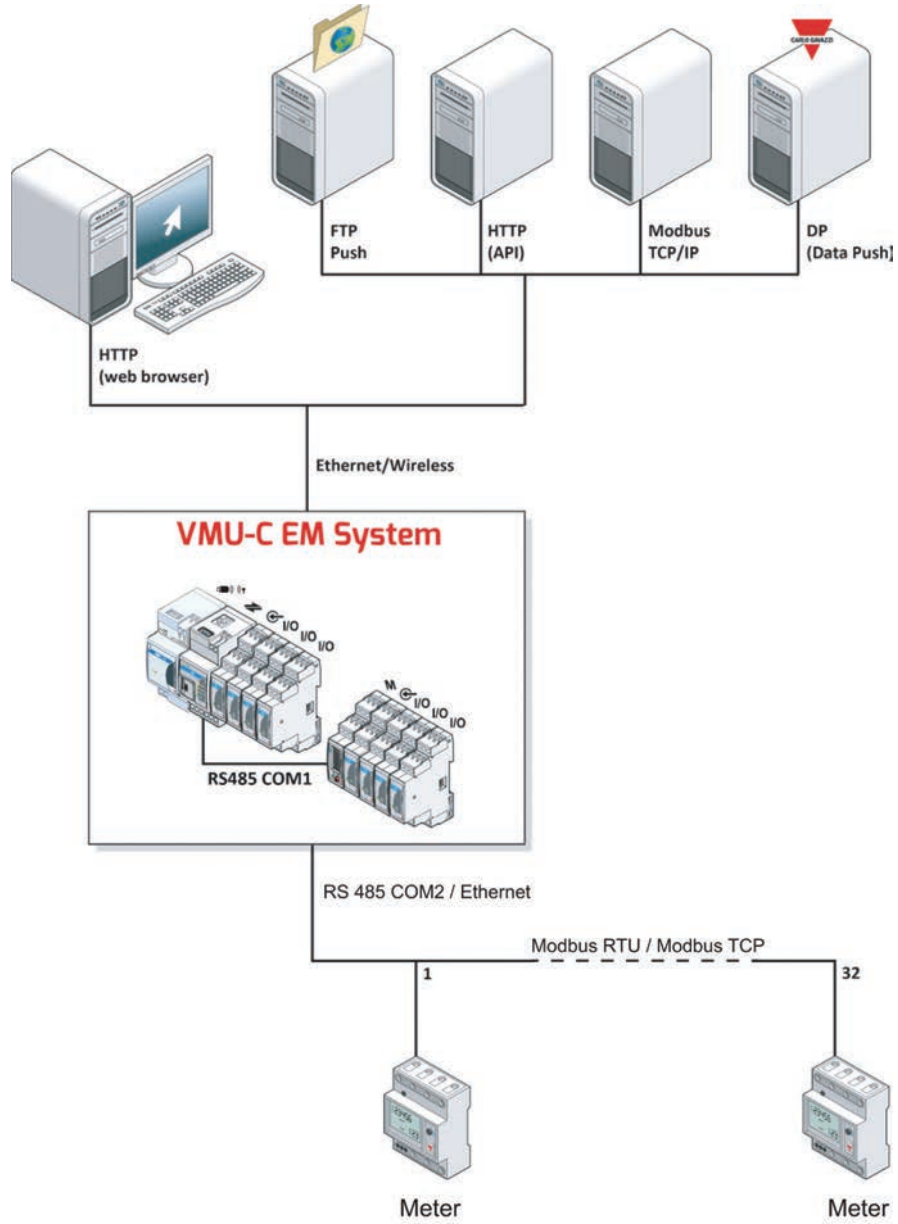

## Features

### General

<b>Material</b>	Noryl, self-extinguishing V-0 (UL94)
<b>Assembly</b>	DIN rail
<b>Protection grade</b>	Front: IP40, Terminals: IP20
<b>Terminals</b>	Section: 1.5 mm <sup>2</sup> maximum; Torque: 0.4–0.8 Nm
<b>Over voltage category</b>	Cat. III (IEC 60664)
<b>Rejection (CMRR)</b>	>65 dB, from 45 to 65 Hz

### Environmental

<b>Working temperature</b>	From -25 to +55 °C/ from -13 to +149 °F (relative humidity <90% without condensation @ 40 °C/104 °F). If at least one VMU-O EM module is installed, check "Working temperature with VMU-O EM module" below.
<b>Assembly Storage temperature</b>	From -30 to +70 °C / from -22 °F to +158 °F (relative humidity <90% without condensation @ 40 °C / 104 °F).

Note: R.H. < 90% non-condensing @ 40°C (104°F)



### Working temperature with VMU-O EM module

The maximum VMU-O EM module input current affects its connected module working temperatures.

Maximum current VMU-O EM [A]	Working temperature	
	[°C]	[°F]
2.5	From -25 to +55	From -13 to +149
3	From -25 to +55	From -13 to +140
3.5	From -25 to +55	From -13 to +131
4	From -25 to +50	From -13 to +122
5	From -25 to +40	From -13 to +104



**Compatibility and conformity**

<p><b>Electromagnetic compatibility (EMC) - immunity</b></p>	<p>Reference: EN61000-6-2                      Electrostatic discharges: EN61000-4-2: 8kV air discharge, 4kV contact                      Immunity to irradiated electromagnetic fields EN61000-4-3: 10V/m from 80 to 3000MHz                      Immunity to Burst EN61000-4-4: 4kV on power lines, 2kV on signal lines                      Immunity to conducted disturbances: EN61000-4-6: 10V from 150KHz to 80MHz                      Surge: EN61000-4-5: 500V on power supply.</p>
<p><b>Electromagnetic compatibility (EMC) - emissions</b></p>	<p>Radio frequency suppression: EN61000-6-3, CISPR 22, class B</p>
<p><b>Approvals</b></p>	<p> </p>

# VMU-C EM main module

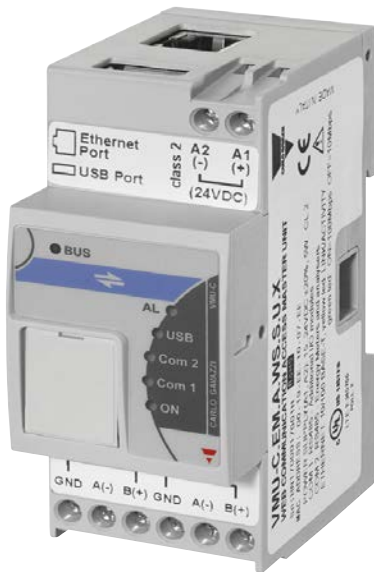

## Description

VMU-C EM is the main VMU-C EM system module. It is a micro PC pre-installed with a web server with pages viewable via browser. It monitors the system, recording and transmitting energy meters data. It communicates via various communication protocols (FTP, HTTP, Modbus TCP/IP) in wired connection. If connected to the modem module (VMU-D module) it also communicates via wireless 3G mobile network. If set in the system, it controls modules to manage analog variables (VMU-P) and digital inputs and outputs (VMU-O). Control can be direct via local bus or indirect via Modbus RTU serial communication with the VMU-M EM module.

## Main features

- Micro-PC with web server
- Adaptive database according to connected meters (up to 32 3-phase meters or 45 1-phase meters)
- Managed variables: DC and AC electrical variables (kWh, kvarh, kW, kvar, kVA, V, A), THD, PF
- Other managed data: analogue variables, digital inputs/outputs, utility meters and totalizers
- Local storage of system data and event for up to 30 years
- Backup on external devices
- Communication ports: RS485 Modbus RTU, Ethernet, local bus, mini-USB
- Supported protocols: FTP, DP(Data Push), HTTP, Modbus TCP/IP, SMTP
- Friendly user interface accessible via standard web browser
- Free integrated software updates, easy to download and install via web interface
- 2-DIN size

## Main functions

- Record and display meters and accessory module data
- Monitor data according to user needs
- Manage alarms
- Transmit logged data to external systems on the local or distributed network
- Set up the entire system

Structure

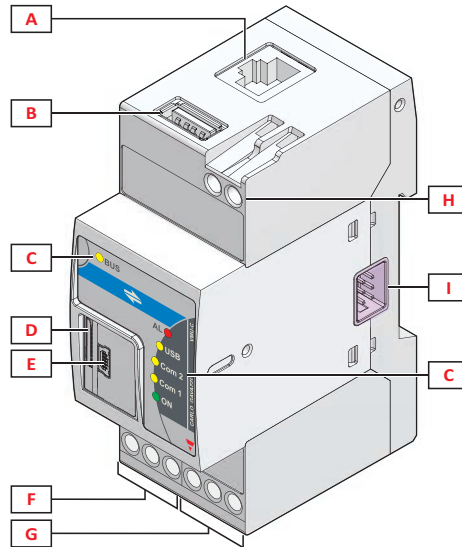

Element	Component	Function
A	Ethernet port	Displaying the web interface and transmitting data to remote systems via wired connection
B	USB Port (Host function)	Permitting data backup on USB flash drive (not supplied)
C	Information LED	Indicating the following statuses: local bus connection (BUS) alarms (AL) USB key (USB) RS485 COM1 port (COM1) RS485 COM2 port (COM2) module power and backup to Micro SD (On)
D	Micro SD memory card slot	Permitting data backup to Micro SD (not supplied)
E	Mini-USB port (Device function)	Connecting a PC to view the web interface if there are connection problems via Ethernet port and permitting backup to PC
F	RS485 COM1 port terminals	Connecting VMU-M EM accessory modules
G	RS485 COM2 port terminals	Connecting meters and analyzers
H	Power terminals	Powering the module
I	Local bus port (left side and right side)	Left side: connecting the VMU-D accessory module to the local bus. Right side: connecting VMU-P EM or VMU-O EM accessory modules to the local bus.



# Features

## General

<b>Operating system</b>	Linux
<b>Dimensions</b>	2-DIN
<b>Weight</b>	< 600 g (packaging included)
<b>Mean time to failure</b>	MTTF/MTBF: 12 years. Test conditions: gf (ground, fixed), 50 °C. Standard: MIL-DBK-217F

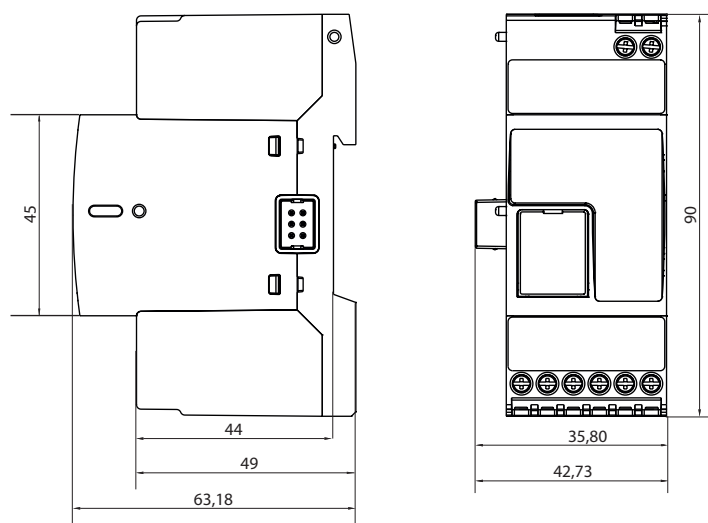

## Power Supply

<b>Power Supply</b>	12–28 VDC
<b>Consumption</b>	≤ 5 W

Power supply sizing guidelines based on the connected optional modules are reported in the following table.

VMU-O EM (quantity)	VMU-P EM *(quantity)	VMU-D (quantity)	Consumption (W)	Start-up current (A)	Power supply order code
0	0	0	2.5	4.5 for 1s	18 W: SPD 24 18 1B; 30 W: SPM3 24 1
≤ 1	≤ 1	0	5	6 for 1s	18 W: SPD 24 18 1B; 30 W: SPM3 24 1
2 or 3	≤ 1	1	10.6	13 for 1s	60 W: SPD 24 60 1B; SPM4 24 1

Note \*: CARLO GAVAZZI wind sensor consumption (code DWS-V) included.  
 Note: one VMU-C EM module consumption included.

**Input/output isolation**

Type	Power	RS485 COM1	RS485 COM2	Ether-net	USB	Mini-USB	Local Bus (VMU-D)	Local bus (VMU-P/O)	VMU-P inputs	VMU-O digital inputs	VMU-O relay output
Power	-	2	2	0.5	0	0	0	0	0	0	4
RS485 COM1	2	-	0.5	2	2	2	2	2	2	2	4
RS485 COM2	2	0.5	-	2	2	2	2	2	2	2	4
Ether-net	0.5	2	2	-	0.5	0.5	0.5	0.5	0.5	0.5	4
USB	0	2	2	0.5	-	0	0	0	0	0	4
Mini-USB	0	2	2	0.5	0	-	0	0	0	0	4
Local bus (VMU-D)	0	2	2	0.5	0	0	-	0	0	0	4
Local bus (VMU-P/O)	0	2	2	0.5	0	0	0	-	0	0	4
VMU-P inputs	0	2	2	0.5	0	0	0	0	-	0	4
VMU-O digital inputs	0	2	2	0.5	0	0	0	0	0	-	4
VMU-O relay output	4	4	4	4	4	4	4	4	4	4	-

Key

- **0**: inputs/outputs are not insulated.
- **0.5**: 0.5kV rms isolation (functional insulation).
- **2**: 2 kV rms isolation (EN 61010-1, IEC 60664-1, Over voltage category III, pollution grade 2, double isolation on system with maximum 300Vrms to ground).
- **4**: EN61010-1, IEC60664-1 - Over-voltage category III, Pollution degree 2, double insulation on systems with max. 300Vrms to ground

## Ports

### Ethernet

<b>Standard</b>	ISO9847
<b>Protocols</b>	HTTP, FTP, Modbus TCP/IP, DP (Data Push), SMTP, INTP
<b>Client connection</b>	Maximum 20 simultaneous client connections (one administrator at a time)
<b>Connection type</b>	RJ45 connector (10 Base-T, 100 Base-TX); maximum distance: 100 m

### Auxiliary bus

<b>Communication function</b>	Master
<b>Compatibility</b>	Right side: VMU-P EM or VMU-O EM accessory modules Left side: VMU-D accessory module

### USB

<b>Type</b>	High speed USB, 2.0 - A (250 mA maximum)
<b>Mode</b>	Hot swap
<b>Communication speed</b>	60 MB/s
<b>Function</b>	<ul style="list-style-type: none"> <li>• "H" - Host</li> <li>• Permitting internal database backup.</li> <li>• Windows 7 and Windows 10 driver download (required to access the web server via mini-USB port).</li> </ul>
<b>Terms of use</b>	Can be used in parallel with mini-USB port. Cannot be used if the VMU-D accessory module is already connected and enabled.

### Micro SD slot

<b>Type</b>	Industrial (from -25 to +85 °C / -13 to + 185 °F) - not supplied
<b>Capacity</b>	SD: up to 2 GB SDHC: 4–16 GB
<b>Function</b>	Permitting internal database backup.



**Mini-USB**

<b>Type</b>	High speed USB 2.0 - mini
<b>Mode</b>	Hot swap
<b>Speed</b>	60 MB/s
<b>Function</b>	<ul style="list-style-type: none"> <li>• "D" Devices</li> <li>• Accessing the web interface without Ethernet connection*</li> <li>• Configuring the system, updating firmware, and downloading measured data and events.</li> </ul>
<b>Condition of use</b>	Can be used in parallel with USB port. Cannot be used if the VMU-D accessory module is already connected.

Note\*: this requires a specific driver be installed on the PC. The driver is automatically downloaded by the module the first time a USB key is connected. This procedure is required for PC with operating system up to Windows 7 and Windows 10. Available as a standard driver with Windows 8.

**RS485**

<b>COM1 port</b>	Maximum 10 VMU-M EM accessory modules
<b>COM2 port</b>	Maximum 32 CARLO GAVAZZI 3-phase energy meter and power analyzer devices*
<b>Communication type</b>	Multidrop, two-way (static and dynamic variables)
<b>Connection type</b>	2 wires, maximum distance 1000m (with repeater)
<b>Protocol</b>	MODBUS/JBUS (RTU)
<b>Data</b>	All
<b>Data format</b>	Selectable: 1 start bit, 7/8 data bits, no/even/odd parity, 1/2 stop bits
<b>Transmission speed</b>	Selectable: 9.6kbps / 19.2kbps / 38.4kbps / 115.2kbps
<b>Driver input capability</b>	1/8 unit load. Maximum 256 nodes on a network

\* The maximum number of meters depend on the meters' type (1-phase, 3-phase) and configuration.

**Connected meter limits**

Type of Meter	History log interval(months) Vs. data granularity(minutes)**			
	Max Meter	5 minutes	10 minutes	15 minutes
1-phase meters	45	6	12	18
3-phase meters*	32	6	12	18
DC meters	64	6	12	18
EM270 family (6.1P configuration)	10	6	12	18
EM270 family (3.2P configuration)	16	6	12	18

Note\*: calculation based on 3-phase meter of average complexity; limits can change for meters of higher complexity.

Note\*\*: the history log interval will automatically increase if less meter than the maximum are connected.



## Data recording

### Recording on internal memory

<b>RAM</b>	128MB
<b>Flash</b>	4 GB available for variables, configurations, variables, alarms and events. FIFO storage window depending on the managed datapoints (1)
<b>Recorded information</b>	Meter variables and accessory module analogue inputs (see "Data management" Pag. 14) Alarm on variables' set-points Status change of accessory modules, power supply and I/Os System configuration XML driver to read external devices Firmware update file
<b>Variable recording mode</b>	The system calculates the average, minimum, maximum values of the measured variables in a time interval and saves it. Three interval ranges are available: a) maximum granularity (5-60 minutes) ; FIFO dynamically managed (e.g. 6 months with 32 3-phase meters) b) daily granularity; up to 30 years of storage c) monthly granularity; up to 30 years of storage
<b>Event and alarm re-recording mode</b>	Events and alarms are always recorded one by one.

Notes: (1) see table "Connected meter limits"

### Data backup via external devices

External devices can be connected to back up internal memory data. Backup is automatic and daily. The following table displays the available information Vs. the external device in use.

Note: if several external devices are connected, the Micro-SD takes priority.

Operation	Information	Micro-SD	USB key	PC via mini-USB
<b>Download (from VMU-C EM)</b>	Variables, alarms and events	x *	x *	x *
	System configuration	x	x	x
	Driver for PC access to the web server via mini-USB	x	x	-
<b>Upload (to VMU-C EM)</b>	Variables, alarms and events	x *	x *	-
	System configuration	x	x	x
	XML driver to read external devices (i.e. energy meters)	-	-	x
	Firmware update	-	-	x

Note\*: full database is saved in proprietary format; weekly report is saved in HTML format compatible with Excel or other spreadsheets.

# Data management

## Management and transmission modes

Meter variables are collected by the main VMUC EM module via RS485 COM2 port and recorded in the internal memory for being then transmitted and viewed remotely. I/O variables and conditions are transmitted to the main VMU-C EM module via local bus or RS485 COM1 port based on system architecture. Data from accessory modules connected to the VMU-M EM module local bus are recorded in the internal VMU-M EM memory and then transmitted to VMU-C EM. All data are recorded in the internal VMU-C EM main module memory for being then transmitted and viewed remotely.

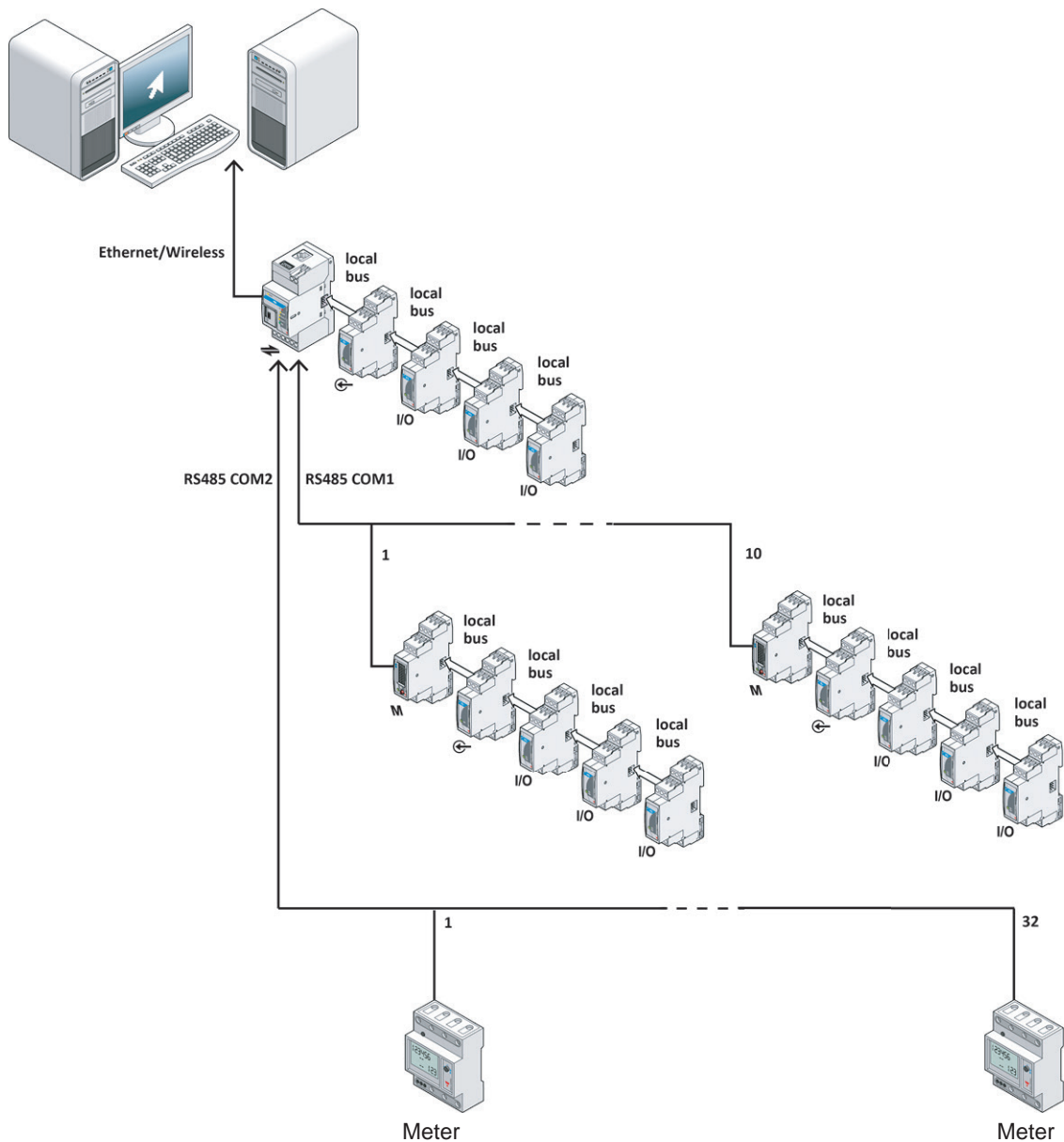

**Meter variables transmission modes**

Variables		Transmission				
		HTTP (web browser)	FTP	Modbus TCP/IP	HTTP (API)	Data Push
Active Energy	kWh	X	X	X	X	X
Active Energy per tariff	kWh per tariff*	X	-	-	-	-
Reactive Energy	kvarh	X	X	X	X	X
Reactive Energy per tariff	kvarh per tariff*	X	-	-	-	-
Phase voltage	V, V L-N sys, V L1-N, V L2-N, V L3-N	X	X	X	X	X
Mains voltage	V L-L sys, V L1-L2, V L2-L3, V L3-L1	X	X	X	X	X
Current	AL1, AL2, AL3	X	X	X	X	X
Active power	kW, kW sys, kW L1, kW L2, kW L3	X	X	X	X	X
Reactive power	kvar sys, kvar L1, kvar L2, kvar L3	X	X	X	X	X
Apparent power	kVA sys, kVA L1, kVA L2, kVA L3	X	X	X	X	X
Average power required	W dmd *	-	-	-	-	X
Maximum power required	W dmd max	-	-	-	-	X
Power factor*	PF sys, PF L1, PF L2, PF L3	X	X	X	X	X
Phase sequence	Phase sequence	X	X	X	X	X
Frequency	Hz	X	X	X	X	X
THD in current	THD A L1, THD A L2, THD A L3	X	X	X	X	X
THD in voltage	THD V L1-N, THD V L2-N, THD V L3-N	X	X	X	X	X
Utility meters (i.e. water, gas)	Totalizer	X	X	X	X	X

Note\*: measure calculated by VMU-C EM based on other measurements or configuration parameters.

**Meter operating modes**

The VMU-C EM manages a single total meter (main meter) and several partial meters. The system automatically sets a virtual one that acts at the system total meter. You can set whether or not each partial meter contributes to the main virtual meter.



▶ Transmission method for I/Os variables and conditions

Information	Transmission				
	HTTP (web browser)	FTP	Modbus TCP/IP	HTTP (API)	Data Push
Temperature 1 (VMU-M EM / VMU-P EM)	X	X	X	X	X
Temperature 2 (VMU-M EM / VMU-P EM)	X	X	X	X	X
Analog input (VMU-P EM)	X	X	X	X	X
Pulse speed input (VMU-P EM)	X	X	X	X	X
Output On/Off status alerting (VMU-O EM)	X	X	-	X	X
System status (i.e.: power supply)	X	X	-	X	X
Alarms ("Managed alarms" Pag. 17)	X	X	-	X	X





## Managed alarms

### ▶ Alarm features

<b>Involved variables and conditions</b>	See "List of variables and conditions with associated alarms"
<b>Management method</b>	See "List of variables and conditions with associated alarms"
<b>Alarm type</b>	Virtual: triggers alarm recording and alerting (web interface/email/text message) Real: triggers alarm recording and alerting (web interface/email/text message) and controls the VMU-O EM accessory module digital output status.
<b>Alarm mode</b>	When either a rising threshold condition or a falling threshold condition is detected
<b>Threshold regulation</b>	0–100% of the range
<b>Hysteresis</b>	From 0 to full scale
<b>Trigger delay</b>	0–3600 s

### ▶ List of variables and conditions with associated alarms

Source module	Measurement or status
<b>VMU-C EM</b>	Any meter variable, see "Data management" Pag. 14
<b>VMU-C EM/ VMU-M EM</b>	No COM1 or COM2 communication
	Communication problems with local bus, more than one VMU-P EM connected to the local bus, system module settings change, inconsistent programming parameters
<b>VMU-M EM</b>	Input temperature 1
	Input temperature 2
	Short circuit at probe 1 or probe 2 input, open circuit at probe 1 or probe 2 input, inconsistent programming parameters
<b>VMU-O EM</b>	Inconsistent programming parameters
<b>VMU-P EM</b>	Input temperature 1
	Input temperature 2
	Analog input
	Pulse rate input
	Short circuit at probe 1 or probe 2 input, open circuit at probe 1 or probe 2 input, inconsistent programming parameters

## Communication protocols

### Introduction

The VMU-C EM module communicates via web interface for set-up, monitoring and system configuration and it transmits data to remote systems (gateway/bridge functions). Different TCP/IP based communication protocols can be used. All protocols are supported by wired and wireless connection and managed on both local network (LAN) and remote one (WAN).

### Protocol overview

Protocol	Type	Transmission mode from VMU-C EM	Data	VMU-C EM function
HTTP (web browser)	Standard	Pull	All	Monitoring, configuration
FTP	Standard	Push	All	Gateway
Modbus TCP/IP	Standard	Pull	Variables selection	Gateway
HTTP (API)	Standard	Pull	All variables selection by API	Gateway
DP (Data Push), based on HTTP	Property of CARLO GAVAZZI	Push	All	Gateway

### Inbound TCP/IP communication

TCP/IP port number	TCP/IP port description	Purpose
80	HTTP	Access to the internal web-server
52325	SSH	Remote service (reserved to support personnel)

### Outbound TCP/IP communication

TCP/IP port number	TCP/IP port description	Purpose
23	DNS	Domain name resolution
37	NTP	Network time services access
21	FTP	Data upload to FTP server
25	SMTP	Email message dispatching
80	HTTP	DP (data push communication)



**▶ Modbus TCP communication**

TCP/IP port number	TCP/IP port description	Purpose
502 (selectable)	Modbus (TCP)	Modbus TCP data communication: both master and slave

**▶ Notes on FTP protocol**

At the set deadlines, data is grouped in CSV format files and uploaded to the set FTP server. In the event of upload error, the operation is repeated.

**▶ Notes on Modbus TCP slave function**

You can set which variables from which meters are to be transmitted. Configuration parameters (devices' addresses and TCP Modbus mapping) defined on the web server can be exported in PDF or XML format for easier configuration of the Modbus/TCP master.

**▶ Notes on HTTP (web browser)**

The user interface for plant monitoring and system configuration is accessible via a standard web-browser.

**▶ Notes on DP (Data Push)**

Data Push protocol is property of CARLO GAVAZZI and is HTTP based. It guarantees VMUC EM module data synchronization with CARLO GAVAZZI server solutions. For multi-site systems management (VMU-Y EM and Em<sup>2</sup> Server).

**▶ Notes on Modbus TCP master function**

By means of Modbus/TCP communication the following types of meters can be connected to VMU-C EM:  
 a) meters with ethernet interface  
 b) meters with RS485 interface + Serial Modbus to Modbus/TCP converter



# Web interface

## Introduction

The web interface is accessible with a normal PC browser connected to the VMU-C EM via Ethernet port, mini-USB port or wireless connection with the VMU-D accessory module.



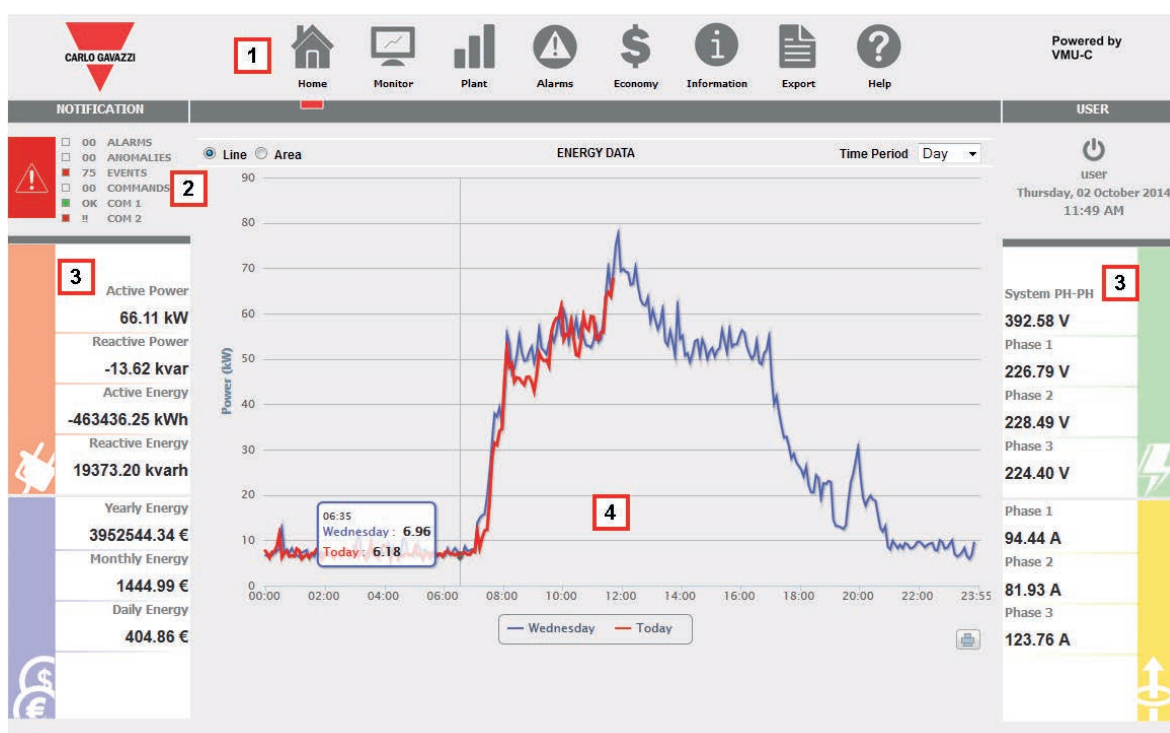





## Interface structure

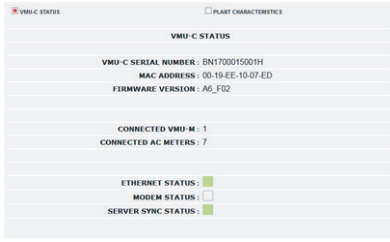

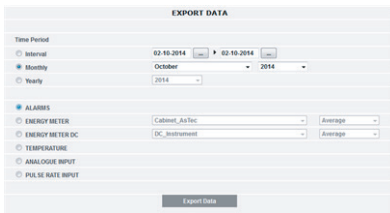

Area	Description
1	Menu bar
2	Alarms and events summary; COM ports communication status
3	System summary information
4	Data charts, configuration settings

**Main functions**

Symbol	Purpose	Example
<p><b>Home</b></p>	<p>Displaying main meter's consumption profile (present trend compared with the past working day/week/month)</p>	
<p><b>Monitor</b></p>	<p>Displaying energy meters data (current, voltage, power, power factor, analog variables) in charts (daily, monthly, yearly).</p>	
<p><b>Plant</b></p>	<p>Displaying:                      energy consumption data, utility meters totalizers and analog inputs                      real-time energy meters data                      customized trends from variable group trends</p>	
<p><b>Alarms</b></p>	<p>Displaying alarms, anomalies, events and recorded commands; manual commands panel</p>	
<p><b>Economy</b></p>	<p>Displaying system costs, calculated based on set tariff data and energy consumption measured by meters</p>	

Symbol	Purpose	Example
 <p><b>Information</b></p>	<p>Informing of VMU-C EM status.                      Displaying plant characteristics.                      Displaying database occupation.</p>	
 <p><b>Export</b></p>	<p>Exporting alarms, meter variables and analog variables in a certain period in HTML format compatible with Excel</p>	
 <p><b>Setting</b></p>	<p>Setting the entire system, specifically:</p> <ul style="list-style-type: none"> <li>• connections: LAN, VMU-D module;</li> <li>• communication: FTP, HTTP API, Modbus TCP/IP, Data Push;</li> <li>• settings wizard: the VMU-C EM main module, VMU-M EM, VMU-P EM, VMU-O EM accessory modules with relevant inputs, outputs and alarms;</li> <li>• RS485 COM1 and COM2 ports;</li> <li>• mail server to send alarm signals and recurrent .xls files with system data;</li> <li>• recipients list for email and SMS alerts;</li> <li>• firmware update;</li> <li>• energy tariff profiles;</li> <li>• time and date synchronization with NTP server.</li> </ul> <p>Modbus Editor:                      graphical tool to create, save, edit, download and upload Modbus/RTU and Modbus/TCP drivers to gather variables from whatever Modbus meter.</p>	 
 <p><b>Account</b></p>	<p>Managing user access to VMU-C EM web server</p>	

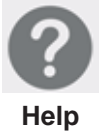

Symbol	Purpose	Example
	Viewing the web server instruction manual	

## Connection Diagrams

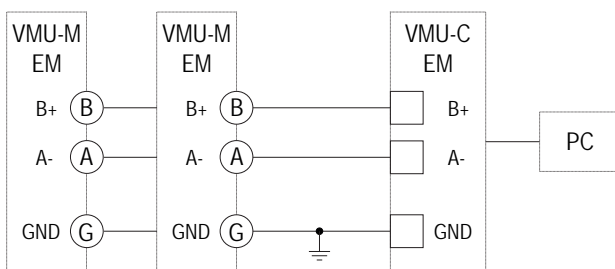

Fig. 1 RS485 COM1 to VMU-M EM modules

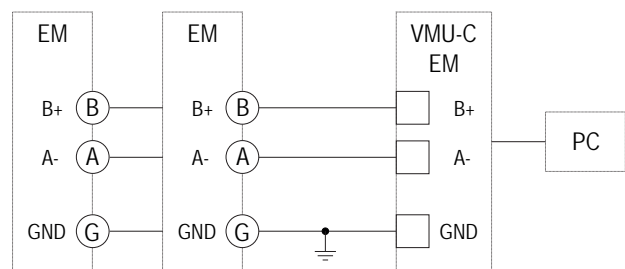

Fig. 2 RS485 COM2 to energy meters

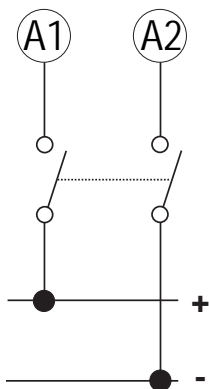

Fig. 3 Power supply

### Note Fig. 1

the serial output must be terminated on the last network device by means of a terminating unit according to Modbus standard; check grounding arrangements specification on the official Modbus documentation for proper grounding connections.



## References

**Further reading**

Information	Document	Where to find it
VMU-C EM instruction manual	VMU-C EM Instruction manual	<a href="http://www.gavazzi-automation.com/">http://www.gavazzi-automation.com/</a>
FTP Push communication protocol	FTP_Service for VMU-C-EM_R1.0.4-communication protocol	Contact Carlo Gavazzi's sales support
HTTP (API) communication protocol	FTP_Service for VMU-C-EM_R1.0.4-communication protocol	Contact Carlo Gavazzi's sales support

**Order code**

**VMUC EM A WS S U X**

**CARLO GAVAZZI compatible components**

Purpose	Component name/code	Notes
Monitoring up to 10 VMU-C EM systems (full data synchronization)	VMU-Y EM	See relevant data sheet
Monitor up to 100 VMU-C EM systems (full data synchronization)	Em <sup>2</sup> -Server	See relevant data sheet
DC energy meter	VMU-E	
Energy analyzer	EM21, EM210, EM24, EM26	
Energy meter	EM100-300 (family), EM12, EM23, EM33, EM270, EM270W, EM271, EM280	
Multifunction meter	WM14	
Power quality analyzers	WM3, WM5, WM30, WM40	
Power transducer	CPT, ET100-300(family)	
VMU-C EM system accessory modules	VMU-D, VMU-M EM, VMU-P EM, VMU-O EM	See following pages



# VMU-M EM accessory module



## Description

VMU-M EM is a VMU-C EM system accessory module that controls accessory modules via local bus so as to manage analog variables (VMU-P EM) and digital inputs/outputs (VMU-O EM). It communicates with the main VMU- C EM module via RS485 port.

## Main features

- Local data and event recording
- Local alarm management
- Accessory modules management: up to one VMU-P EM with analog inputs and up to three VMU-O EM with digital inputs/outputs.
- Two direct inputs (digital or temperature)
- Communication ports: RS485 Modbus RTU and local bus
- 1-DIN size

## Main functions

- Record VMU-P EM and VMU-O EM accessory modules data
- Transmit accessory module data via serial communication to the main VMU-C EM module
- Read data from the one digital input or two temperature inputs for local display and alarm threshold management
- Local display of real time variables
- Manage any local alarms

Structure

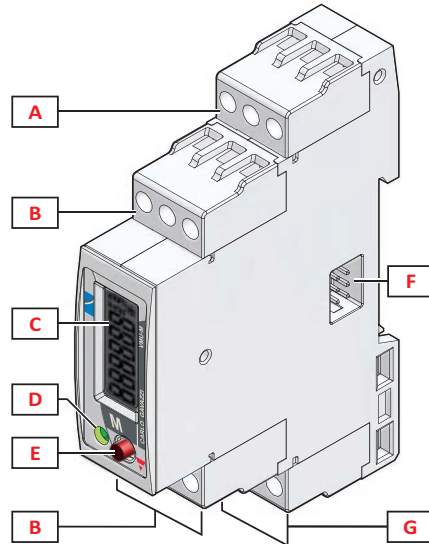

Element	Component	Function
A	RS485 port terminals	Communicating with the VMU-C EM main module
B	Input terminals	Connecting digital or temperature inputs
C	LCD display	Displaying local bus module input variables and some configuration parameters
D	Information LED	Indicating serial communication, power and alarm status
E	Key	Scrolling real time variables and setting some parameters Note: the full configuration is only possible via VMU-C EM main module web interface
F	Local bus port	Connecting up to one VMU-P EM accessory module and up to three VMU-O EM accessory modules to the local bus
G	Power terminals	Powering the module

## Features

### General

<b>Display capacity</b>	6 digits
<b>Dimensions</b>	1-DIN
<b>Weight</b>	About 100 g (packaging included)
<b>Mean time to failure</b>	MTTF/MTBF: 24.2 years. Test conditions: gf (ground, fixed), 50 °C. Standard: MIL-HDBK-217F.

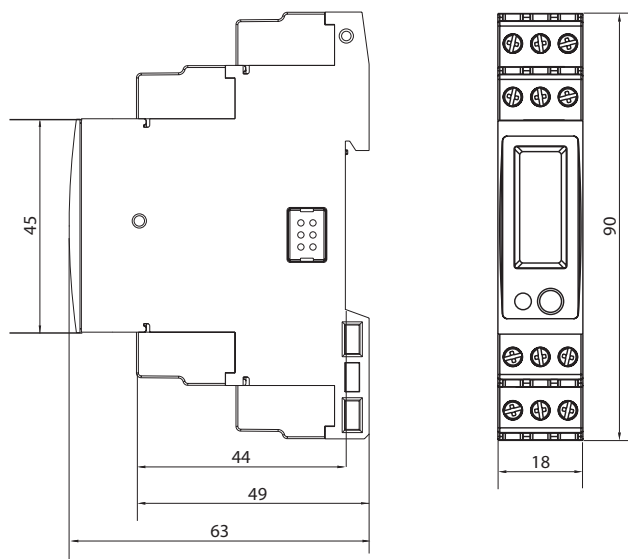

### Power Supply

<b>Power Supply</b>	12–28 VDC
<b>Consumption</b>	≤ 1 W

Power supply sizing guidelines, on the basis of connected accessory modules.

VMU-O EM (quantity)	VMU-P EM *(quantity)	Consumption **(W)	Start-up current (A)	Power supply order code
0	0	2.5	1.5	18 W: SPD 24 18 1B; 30 W: SPM3 24 1
≤ 1	≤ 1	5		18 W: SPD 24 18 1B; 30 W: SPM3 24 1
2 or 3	≤ 1	10.6		60 W: SPD 24 60 1B; SPM4 24 1
Note *: CARLO GAVAZZI wind gauge consumption (p/n DWS-V) included. Note **: VMU-M EM module consumption included.				



**Input/output isolation**

Module		Any	VMU-M			VMU-P			VMU-O	
	Type of input/output	Local bus	DC power supply	Temperature or digital Inputs: Ch1, Ch2	RS485	Temperature: Ch1, Ch2	Analogue input	Pulse rate input	Digitals inputs: Ch1, Ch2	Relay outputs: Ch1, Ch2
<b>Any</b>	Local bus	-	0	0	0	0	0	0	0	4
<b>VMU-M</b>	DC power supply	0	-	0	0	0	0	0	0	4
	Temperature or digital Inputs: Ch1, Ch2	0	0	-	0	0	0	0	0	4
	RS485	0	0	0	-	0	0	0	0	4
<b>VMU-P</b>	Temperature: Ch1, Ch2	0	0	0	0	-	0	0	0	4
	Analogue input	0	0	0	0	0	-	0	0	4
	Pulse rate input	0	0	0	0	0	0	-	0	4
<b>VMU-O</b>	Digitals inputs: Ch1, Ch2	0	0	0	0	0	0	0	-	4
	Relay outputs: Ch1, Ch2	4	4	4	4	4	4	4	4	-

Key

- **0**: 0kV inputs / outputs are not insulated. Use insulated probes and free of voltage contacts inputs.
- **4**: 4kV only if the fuse is not present. Remove the fuse only when the disconnecting breaker is switched off. The fuse is only for over-current protection (it has not to be considered as a disconnecting device).

**Digital Inputs**

<b>Max number of inputs</b>	1
<b>On/Off status detection change</b>	≥ 500 ms
<b>Contact reading voltage</b>	3.3V
<b>Contact reading current</b>	< 1 mA
<b>Contact resistance</b>	≤ 1 kΩ closed contact, ≥ 20 kΩ open contact



**Temperature Inputs**

<b>Max number of inputs</b>	1
<b>Probe</b>	Pt100 or Pt1000 thermistor
<b>Connection type</b>	2 or 3 wires
<b>Connection compensation</b>	Up to 10 Ω
<b>Range</b>	From -50 to +200 °C / from -58 to +392 °F
<b>Accuracy (Display and RS485) @ 25 ±5 °C, relative humidity ≤ 60%</b>	From -50 to + 200 °C: ±(0.5% RDG + 5 DGT) / from -58 to +392 °F: ±(0.5% RDG + 5 DGT)
<b>Thermal offset</b>	±150 ppm/°C
<b>Engineering unit</b>	°C or °F, selectable

**RS485**

<b>Communication type</b>	Slave Multidrop, bidirectional (static and dynamic variables)
<b>Connection type</b>	3 wires (A-, B+, Signal GND), maximum distance 1000m
<b>Protocol</b>	MODBUS/JBUS (RTU)
<b>Data</b>	Dynamic (read only): all variables, alarms and events Static (read and write): all configuration parameters
<b>Data format</b>	1 start bit, 8 data bits, no parity, 1 stop bit
<b>Transmission speed</b>	Selectable: 9.6kbps / 19.2kbps / 38.4kbps / 115.2kbps

**Local bus port**

<b>Compatibility</b>	VMU-P EM and VMU-O EM accessory modules
----------------------	---

**Recording on internal memory**

<b>Flash</b>	10000 Records (timestamped sets of measurements) + 10000 Events
<b>Recorded information</b>	Analog variables measured from the module and the connected accessory modules. Status changes of: I/Os, power supply, module's configuration and connected accessory modules' configuration. Module configuration and accessory modules configuration.
<b>Variables recording mode</b>	The system calculates the average value of the measured variables in a time interval and saves it. The interval range is configurable from 5 to 60 minutes.  The embedded database stores locally the average values for a period which depends on the interval: Interval =5 minutes: period = one month Interval =60 minutes: period= one year
<b>Events and alarms recording mode</b>	Events and alarms are always recorded singularly in a FIFO queue (up to 10000 events).

## Connection Diagrams

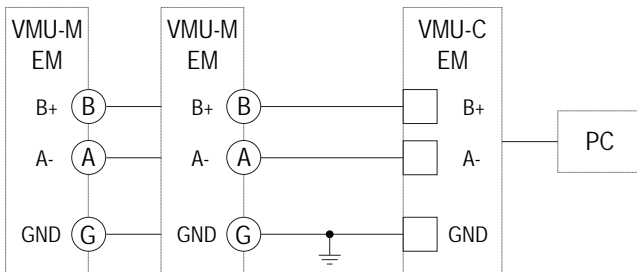

**Fig. 4** RS485 Modbus to VMU-C EM main module

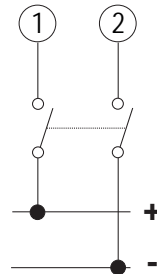

**Fig. 5** Power supply

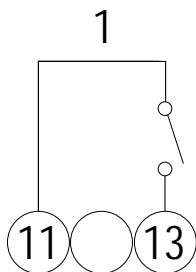

**Fig. 6** Digital input 1

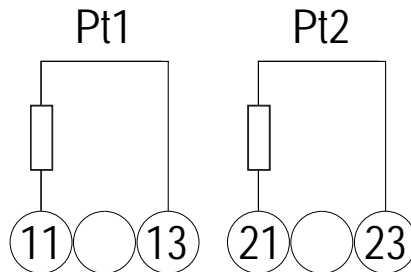

**Fig. 7** Temperature inputs 1 and 2 (2 wires)

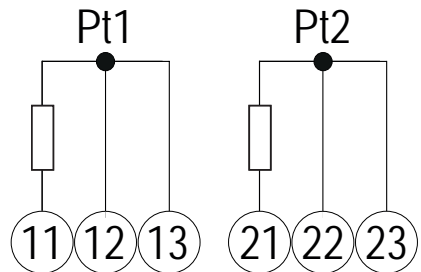

**Fig. 8** Temperature inputs 1 and 2 (3 wires)

**Note Fig. 4**

the serial output must be terminated on the last network device by means of a terminating unit according to Modbus standard; check grounding arrangements specification on the official Modbus documentation for proper grounding connections.

## References

### Further reading

Information	Document	Where to find it
Modbus (RTU) communication protocol	VMU-M EM - Communication Protocol	Contact Carlo Gavazzi's Support

### Order code



**VMUM EM 4 A S1 T2 X**

### CARLO GAVAZZI compatible components

Purpose	Component name/code	Notes
Integrate temperature input	IKE20001K	Water-proof temperature probe Pt1000
	TEMPSOL1000	Temperature sensor Pt1000

# VMU-O EM accessory module



## ▶ Main features

- Two digital inputs and two digital outputs.
- Self-powered via local bus.
- 1-DIN size

## ▶ Main functions

- ON/OFF status detection by means of 2 digital inputs.
- Relay output control by either manual command or event triggering.

## ▶ Description

VMU-O EM is a VMU-C EM system accessory module that manages two digital inputs and two relay outputs.

It can be connected to the main VMU-C EM module or to the VMU-M EM accessory module via local bus.



**Structure**

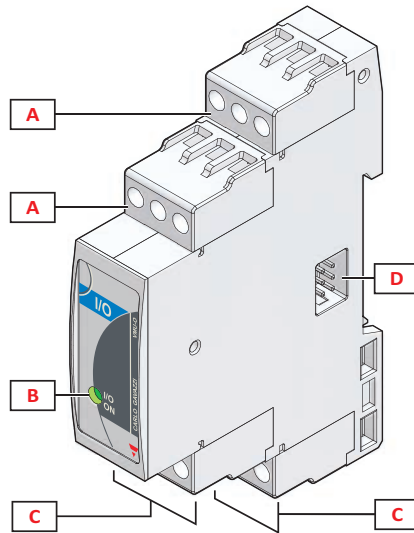

Element	Component	Function
A	Output terminals	Connecting to remote control switches
B	Information LED	Indicating local bus communication status, power supply status, digital input/output status
C	Input terminals	Connecting to digital inputs.
D	Local bus port (right side and left side).	Both sides: connecting to the local bus.

## Features

### General

<b>Dimensions</b>	1-DIN
<b>Weight</b>	About 100 g (packaging included)
<b>Mean time to failure</b>	MTTF/MTBF: 65.4 years Test conditions: gf (ground, fixed), 50 °C Standard: MIL-HDBK-217F

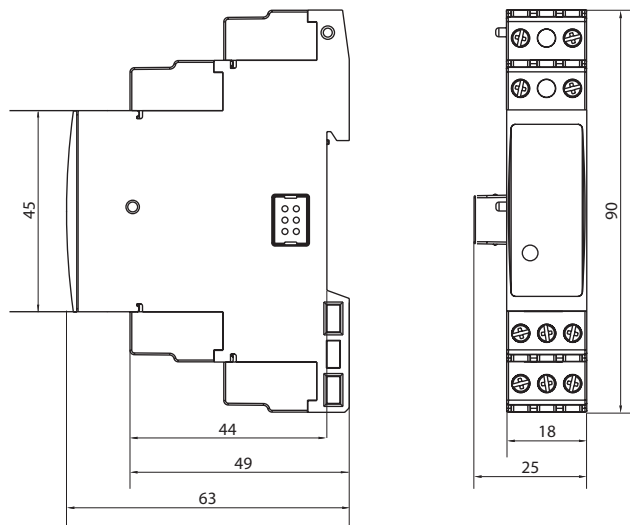

### Power Supply

<b>Power</b>	Self-powered via local bus
<b>Consumption</b>	≤ 0.7 W

### Inputs

<b>Max number of inputs</b>	2
<b>Type</b>	Digital
<b>On/Off status detection change</b>	≥ 500 ms
<b>Contact reading voltage</b>	3.3 VDC
<b>Contact reading current</b>	< 2 mA
<b>Contact resistance</b>	≤ 300 Ω closed contact, ≥ 10 kΩ open contact

**Outputs**

<b>Max number of outputs</b>	2
<b>Type</b>	SPST relay AC1: 5A @ 250 VAC AC15: 1A @ 250 VAC
<b>Activation mode</b>	<ul style="list-style-type: none"> <li>• Triggered by an accessory module's alarm condition</li> <li>• Triggered by main VMU-C EM module's alarm condition</li> <li>• Manual control from the web interface</li> <li>• According to a schedule set in the web interface</li> </ul>
<b>Initial status</b>	Selectable: normally closed or normally open

**Auxiliary bus**

<b>Communication function</b>	Slave
<b>Compatibility</b>	Right side: VMU-P EM or VMU-O EM accessory modules Left side: VMU-M master module, VMU-P EM or VMU-O EM module

## Connection Diagrams

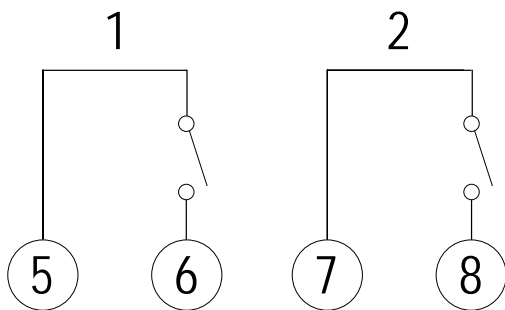

Fig. 9 Digital input 1

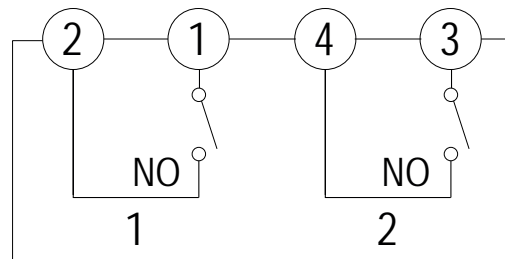

Fig. 10 Digital outputs 1 and 2



## References

**▶ Further reading**

Information	Document	Where to find it

**▶ Order code**

 **VMUO X I2 R2 EM**

**▶ CARLO GAVAZZI compatible components**

Purpose	Component name/code	Notes

# VMU-P EM accessory module



## ▶ Main features

- Four inputs: two temperature, one analog and one pulse rate
- Self-powered via local bus
- 1-DIN size

## ▶ Main functions

- Analogue variables measurement

## ▶ Description

VMU-P EM is a VMU-C EM system accessory module that manages variables that can affect energy efficiency (i.e.: temperature, irradiance). It can connect to the main VMU-C EM module or to the VMU-M EM accessory module via local bus. It has four analogue inputs.

**Structure**

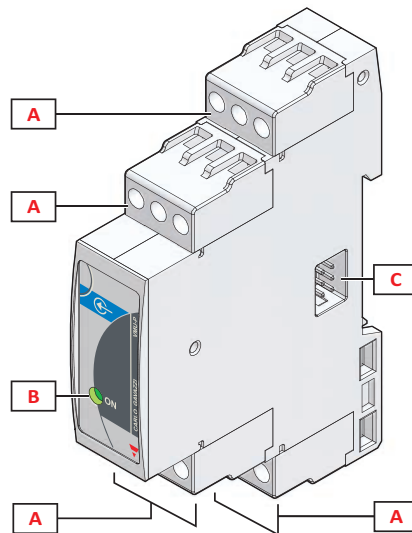

Element	Component	Function
A	Input terminals	Connecting inputs (temperature, 0-20mA or 0-120mV analogue, pulse rate)
B	Information LED	Indicating local bus communication status and power supply status.
C	Local bus port (right side and left side).	Both sides: connecting to the local bus.

# Features

**General**

<b>Dimensions</b>	1-DIN
<b>Weight</b>	About 100 g (packaging included)
<b>Mean time to failure</b>	MTTF/MTBF: 31.7 years Test conditions: gf (ground, fixed), 50 °C Standard: MIL-HDBK-217F

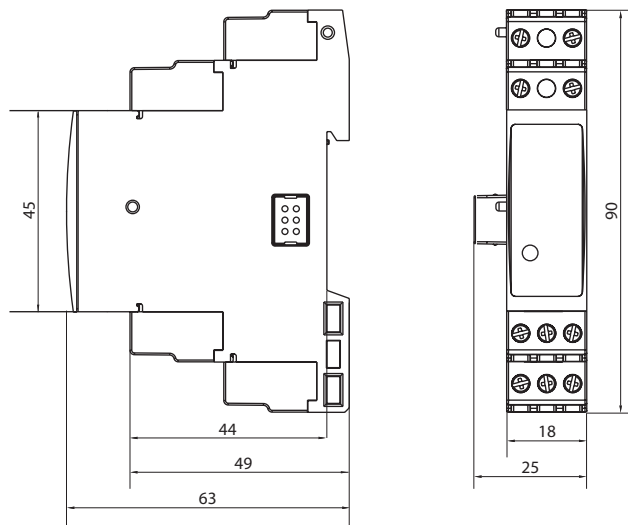

**Power Supply**

<b>Power</b>	Self-powered via local bus
<b>Consumption</b>	≤ 1.8 W including the pulse rate sensor

**Temperature Inputs**

<b>Max number of inputs</b>	1
<b>Probe</b>	Pt100 or Pt1000 thermistor
<b>Connection type</b>	2 or 3 wires
<b>Connection compensation</b>	Up to 10 $\Omega$
<b>Range</b>	From -50 to +200 °C / from -58 to +392 °F
<b>Accuracy (Display and RS485) @ 25 <math>\pm</math>5 °C, relative humidity <math>\leq</math> 60%</b>	From -50 to + 200 °C: $\pm(0.5\% \text{ RDG} + 5 \text{ DGT})$ / from -58 to +392 °F: $\pm(0.5\% \text{ RDG} + 5 \text{ DGT})$
<b>Thermal offset</b>	$\pm 150 \text{ ppm}/^\circ\text{C}$
<b>Engineering unit</b>	$^\circ\text{C}$ or $^\circ\text{F}$ , selectable

**Voltage analogue input (product code: 2TIW)**

<b>Max number of inputs</b>	1
<b>Range</b>	3-120 mVDC
<b>Accuracy (Display and RS485) @ 25 <math>\pm</math>5 °C, relative humidity <math>\leq</math> 60%</b>	0-25% f.s.: $\pm(0.2\% \text{ RDG} + 1 \text{ DGT})$ 25-120% f.s.: $\pm(0.1\% \text{ RDG} + 1 \text{ DGT})$
<b>Temperature drift</b>	$\pm 150 \text{ ppm}/^\circ\text{C}$
<b>Scaling factor</b>	Measurement input: selectable, 3-150 mV DC Display: selectable, 0-9999 (the decimal point position is also selectable)
<b>Impedance</b>	> 30 K $\Omega$
<b>Overload</b>	Continuous: 10 VDC For 1 s: 20 VDC

**Current analogue input (product code: 2TCW)**

<b>Max number of inputs</b>	1
<b>Range</b>	0-20 mADC
<b>Accuracy (Display and RS485) @ 25 <math>\pm</math>5 °C, relative humidity <math>\leq</math> 60%</b>	0-25% f.s.: $\pm(0.2\% \text{ RDG} + 1 \text{ DGT})$ 25-120% f.s.: $\pm(0.1\% \text{ RDG} + 1 \text{ DGT})$
<b>Temperature drift</b>	$\pm 150 \text{ ppm}/^\circ\text{C}$
<b>Scaling factor</b>	Measurement input: selectable, 0-25 mA DC Display: selectable, 0-9999 (the decimal point position is also selectable)
<b>Impedance</b>	$\leq 22 \Omega$
<b>Overload</b>	Continuous: 50 mADC For 1 s: 150 mADC





**Pulse rate input**

<b>Max number of inputs</b>	1
<b>Range</b>	0–1000 Hz, work cycle 50%
<b>Accuracy (Display and RS485) @ 25 ±5 °C, relative humidity ≤ 60%</b>	0–25% f.s.: ±(0.2% RDG + 1 DGT) 25–110% f.s.: ±(0.01% RDG + 1DGT)
<b>Temperature drift</b>	± 150 ppm/°C
<b>Scaling factor</b>	Measurement input: selectable 0–999.9 Hz Display: selectable, 0-9999 (the decimal point position is also selectable)
<b>Input impedance</b>	220 Ω
<b>Overload</b>	Continuous: 7 V RMS / 25 mA RMS (AC/DC) For 1 s: 14 V RMS / 50 mA RMS (AC/DC)

**Auxiliary bus**

<b>Communication function</b>	Slave
<b>Compatibility</b>	Left side: VMU-M EM or VMU-O EM accessory modules. Right side: VMU-O accessory module

## Connection Diagrams

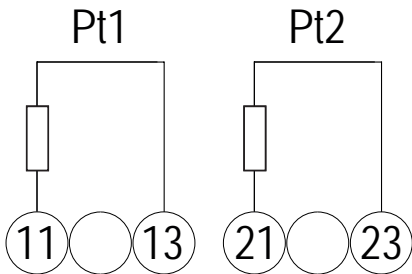

**Fig. 11** Temperature inputs 1 and 2 (2 wires)

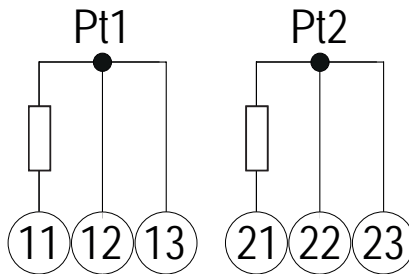

**Fig. 12** Temperature inputs 1 and 2 (3 wires)

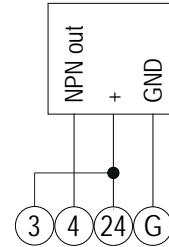

**Fig. 13** NPN impulse input (product code: 2TIW)

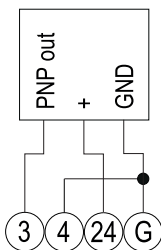

**Fig. 14** PNP impulse input (product code: 2TIW)

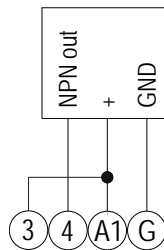

**Fig. 15** NPN impulse input (product code: 2TCW)

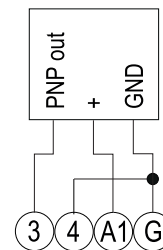

**Fig. 16** PNP impulse input (product code: 2TCW)

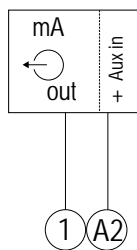

**Fig. 17** Analog current input, 2 wires with incoming current (product code: 2TCW)

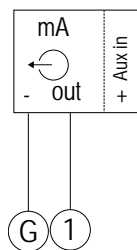

**Fig. 18** Analog current input, 2 wires with outgoing current (product code: 2TCW)

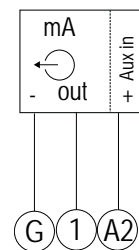

**Fig. 19** Analog current input, 3 wires (product code: 2TCW)

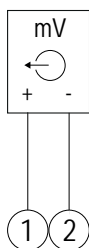

**Fig. 20** Voltage analog input (product code: 2TIW)



## References

**Further reading**

Information	Document	Where to find it

**Order code**

VMUP 2T  W X S EM (12 total characters)

Enter the code entering the corresponding option instead of

Code	Option	Description
V	-	
M	-	
U	-	
P	-	
2	-	
T	-	
<input type="checkbox"/>	C	20mA analogic measuring input
	I	120mV analogic measuring input
W	-	
X	-	
S	-	
E	-	
M	-	

**CARLO GAVAZZI compatible components**

Purpose	Component name/code	Notes
Integrate temperature input	IKE20001K	Water-proof temperature probe Pt1000
	TEMPSOL1000	Temperature sensor Pt1000
Solar irradiance sensing	PVS2A1WXC	2nd Class Pyranometer for certified solar irradiance sensing

# VMU-D accessory module



## Description

VMU-D is a VMU-C EM accessory module, that provides compatible Carlo Gavazzi devices with a reliable and cost effective way to connect to Internet by using mobile networks via dongle modem.

## Main features

- Compatible with VMU-C and VMU-Y family of products
- Mobile Internet connection
- Compatible with USB dongle modems
- Watchdog features to prevent common mobile network hassles

## Main functions

- Remote access by Internet when a wired connection is not available
- Plug'n play configuration
- Reliable operation
- SMS alerting
- SMS commands

**Structure**

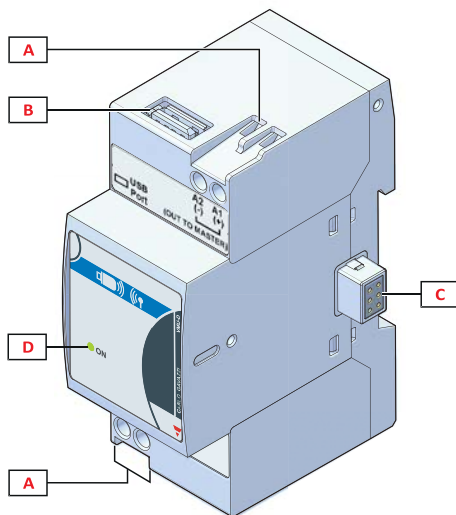

Element	Component	Function
A	Power supply	Power supply connection block (IN, bottom/OUT, top) (Min./Max. screws tightening torque: 0.4 Nm / 0.8 Nm)
B	USB connector	Connecting dongle modem
C	Local bus port	Connecting to the VMU-C/VMU-Y main module
D	Power information LED	LED (green), 2 status Steady off, power OFF Steady on, power ON

**Note:** USB CONNECTION is active if the Dongle is connected AND the VMU-C is connected to the VMU-D AND the power supply is connected AND no USB peripheral connected to VMU-C's USB port

## Features

**General**

<b>Dimensions</b>	2-DIN
<b>Weight</b>	< 600 g (packaging included)
<b>Mean time to failure</b>	MTTF/MTBF: 26 years Test conditions: gf (ground, fixed), 50 °C Standard: MIL-HDBK-217F

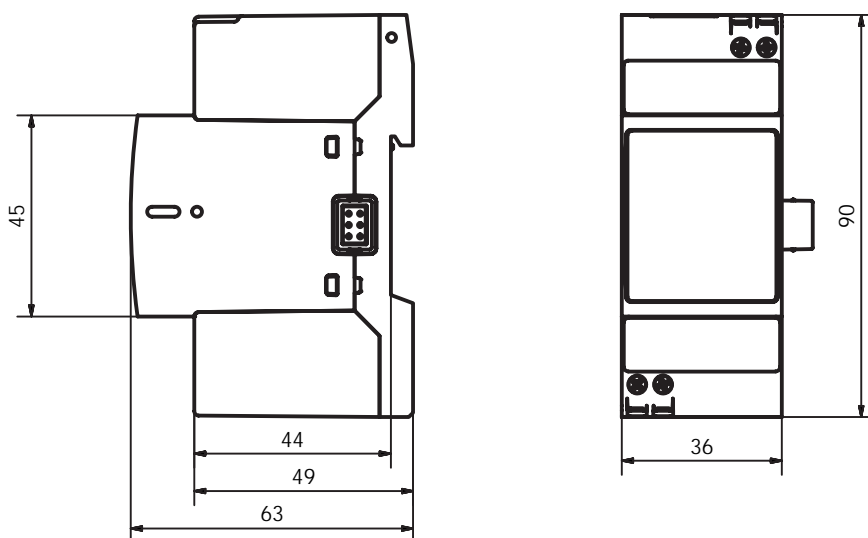

**Power Supply**

<b>Power Supply</b>	12–28 VDC
---------------------	-----------



## Ports

### Auxiliary bus

<b>Local bus connection</b>	Master Proprietary VMU-C connector
-----------------------------	------------------------------------

### USB

<b>Type</b>	USB 2.0 Standard-A receptacle
<b>Terms of use</b>	Mechanically compatible with standard USB dongle modem in the market

## Connection Diagrams

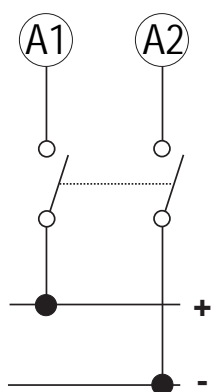

Fig. 21 Power supply



## References

**▶ Further reading**

Information	Document	Where to find it

**▶ Order code**

**👉 VMUDA VDCX**

**▶ CARLO GAVAZZI compatible components**

Purpose	Component name/code	Notes
Embedded Web Server	VMU-C EM	
Embedded data aggregator	VMU-Y EM	
Embedded Web Server	VMU-C PV	
Embedded data aggregator	VMU-Y PV	
3G Modem	HUAWEI MS2131 DLINK DWM 157	Third party



COPYRIGHT ©2015  
Content subject to change download the PDF: [www.productselection.net](http://www.productselection.net)